

AGENT\

SINCE  
1988

Sheet metal  
working  
machines



Shaping your future

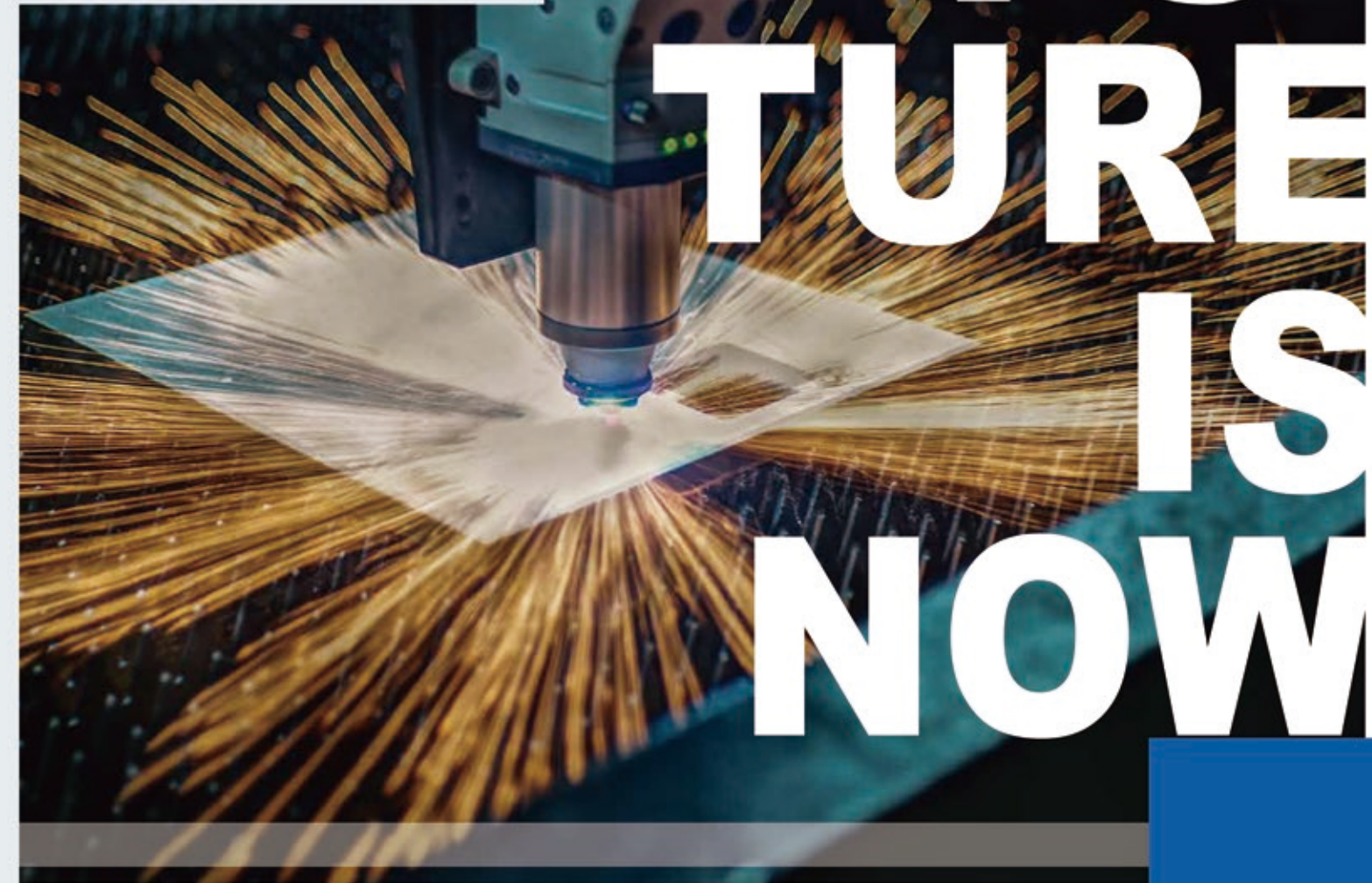

# FUTURE IS NOW

ACCURL MACHINE TOOLS  
CHINA | ACCURLUSA

Industrial Park In Bowang  
Ma'anshan, Anhui, China



QIAOLIAN PLASMA & LASER MACHINE TOOLS

T | +86 555 2780 563  
F | +86 555 2780 553  
E | info@accurl.com

COMPLETE RANGE OF

## FIBER LASER CUTTING MACHINERY

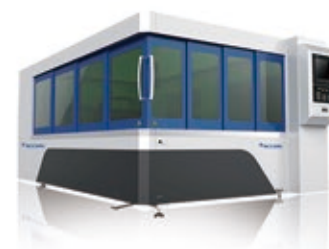

QIAOLIAN LASER



This catalog is not a contractual document and only for illustrative purposes.  
ACCURL reserves the right to modify any specifications within this catalog without prior notice.

ACCURL Laser & Plasma Systems is the company that creates value of the success and shares the value with all our customers.

Based on the continuous investment in R&D, we have developed the laser cutting and bending technologies and products.



Challenge

Change

Creativity

Content

Credibility

#### MISSION

Creating the value of success through customer satisfaction

#### VISION

The company that provides fun and joy

#### VALUE

Challenge · Change · Creativity · Content · Credibility

ACCURL Laser & Plasma Systems is one of the world's leading manufacturers in the field of high power laser cutting machine.

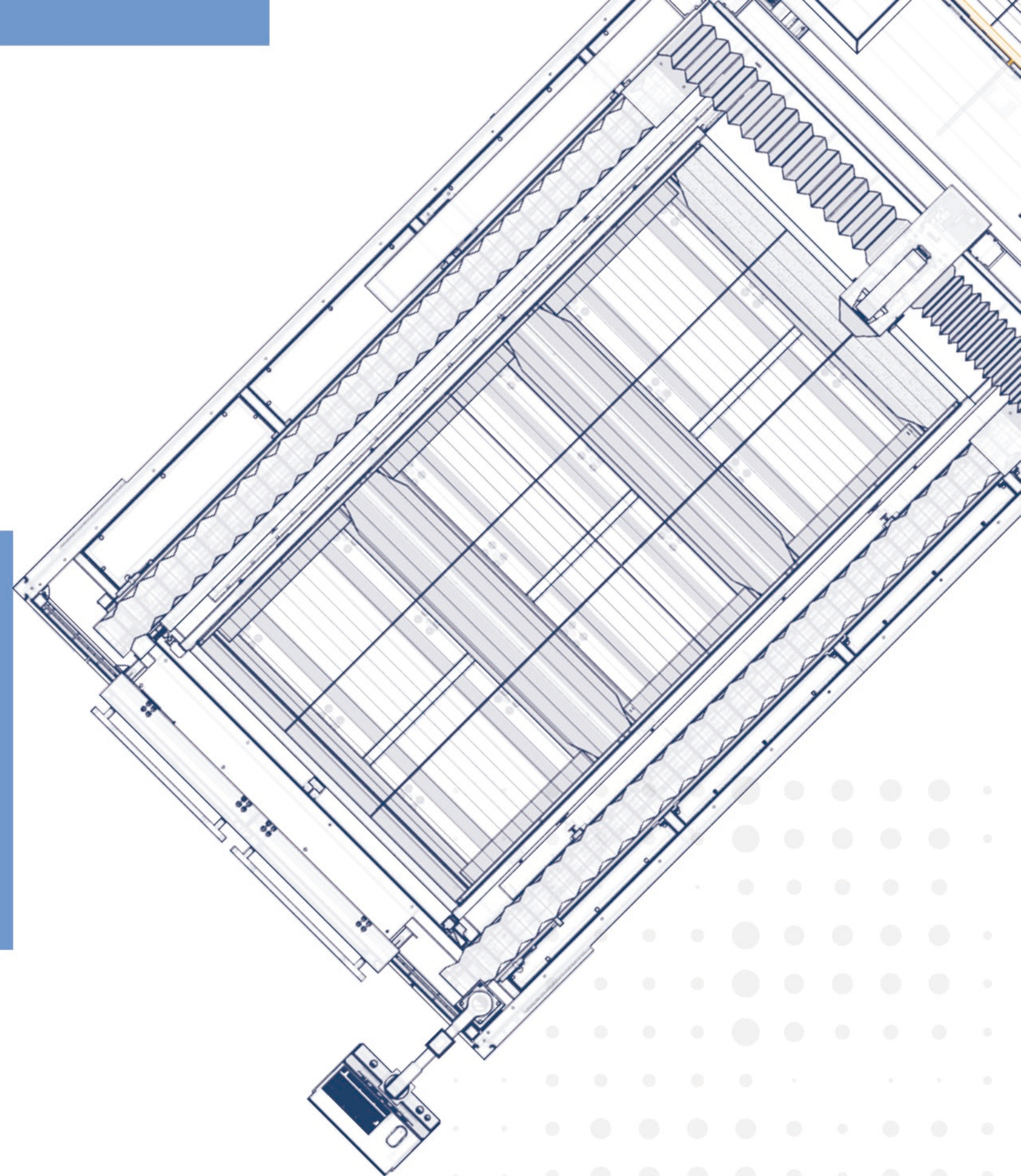
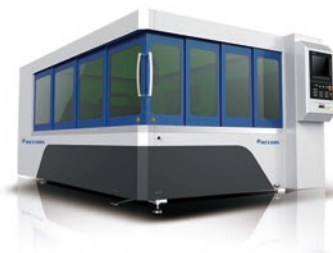

# Global Network

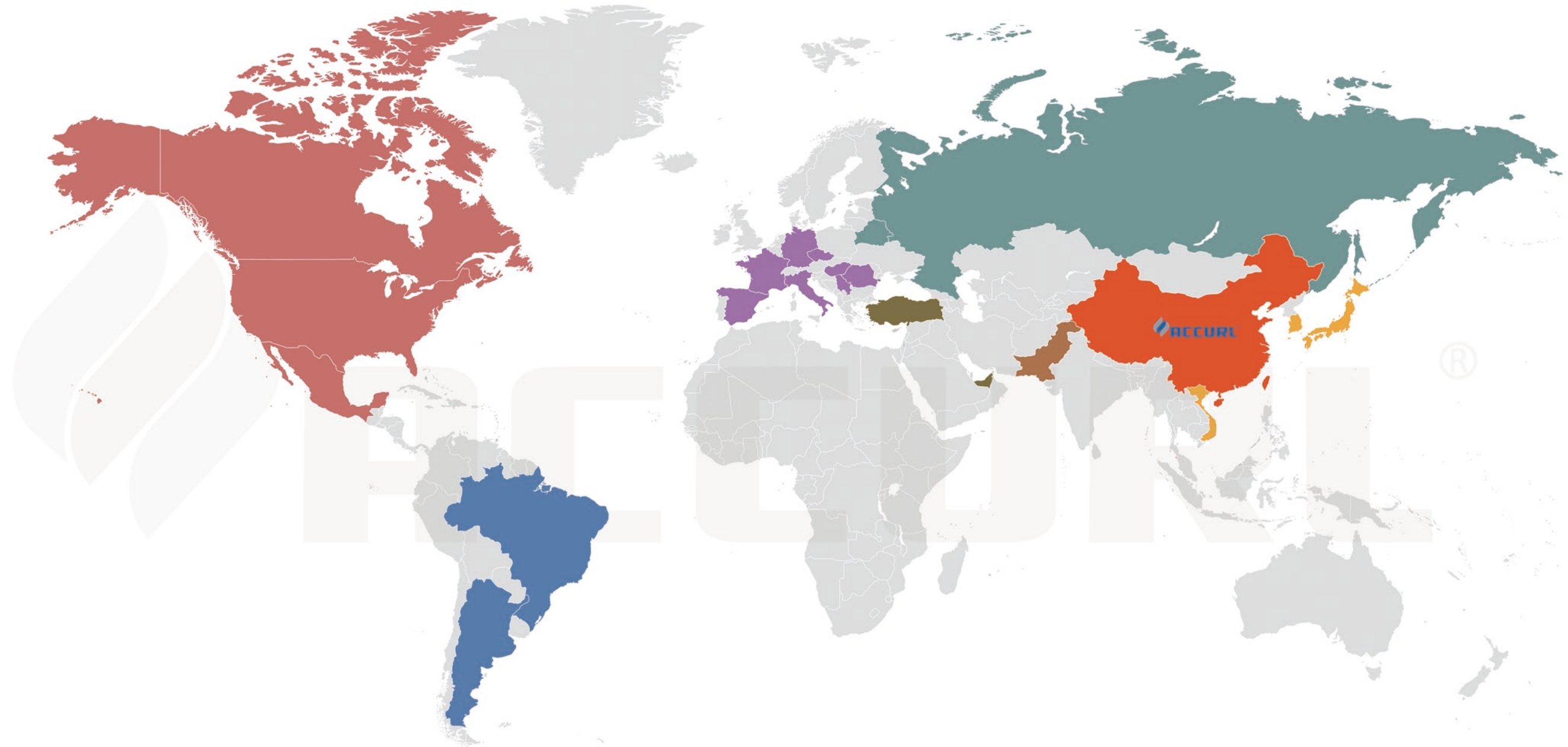

QIAOLIAN-LASER SINCE 1988  
Sheet metal working machines



- Algeria
- Denmark
- Holland
- Middle East
- Sweden
- Australia
- Egypt
- Hungary
- Poland
- Switzerland
- Austria
- USA
- India
- Portugal
- Taiwan
- Belgium
- England
- Italy
- Romania
- Turkey
- China
- Finland
- Jordan
- Russia
- Venezuela
- Colombia
- France
- Morocco
- South Africa
- Czech Republic
- Germany
- Mexico
- Spain

# Pinnacle of Laser Cutting Technology



A territory with a consolidated technological background and the inventiveness of the ACCURL family are the ingredients of the birth of QIAOLIAN•LASER, One of the first company to apply fiber laser technology to the cutting of sheet metal in 2015, thus gaining a substantial technological edge over the competition.

It is a lean and dynamic company that builds customised automated cutting, welding and bending systems and has a widespread sales network around the world.

SINCE 1988

Sheet metal working machines



Shaping your future

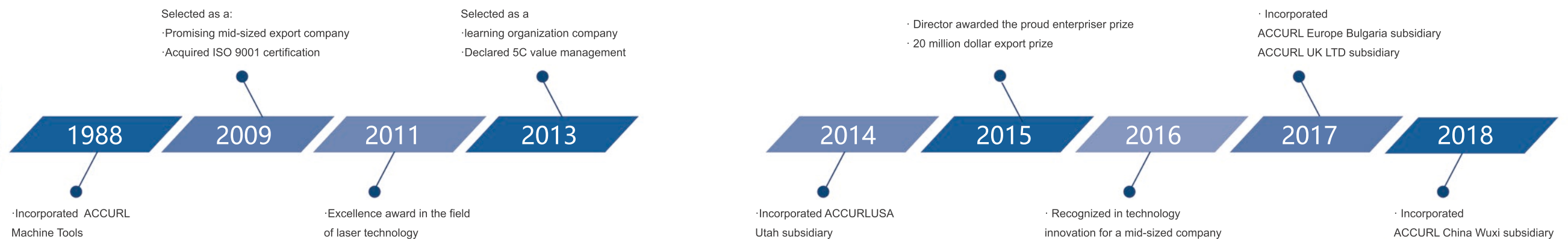



SINCE  
1988

Sheet metal  
working  
machines



Shaping your future

# CONTENTS

We have become leaders in research and development for one reason only:  
offering your company customised solutions to optimise production at the right cost.

Smart KJG Series



Genius Series

**NEW**  
The Genius  
Series



Smartline Series

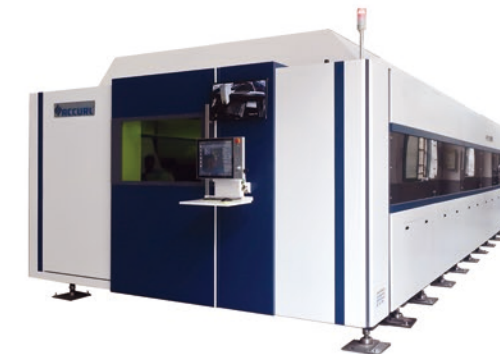
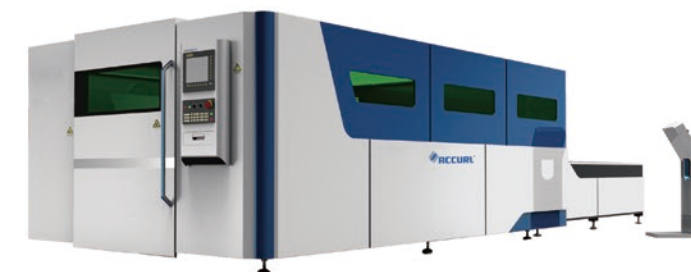

MasterLine Series

**NEW**  
The MasterLine  
Series



**Next level.**

**Next to you.**

Today's volatile market demands that companies be competitive, accurate and reactive. ACCURL products continue to evolve, bringing efficiency to a whole new level.

More productive machines, new automation solutions, and easy-to-use option suites are designed to meet the customer's real needs. To provide the best ACCURL technology, our team of experts will always be available to listen, assist and advise.

## OVERVIEW SERIES

NEW  
The Genius  
series

Smart



Genius

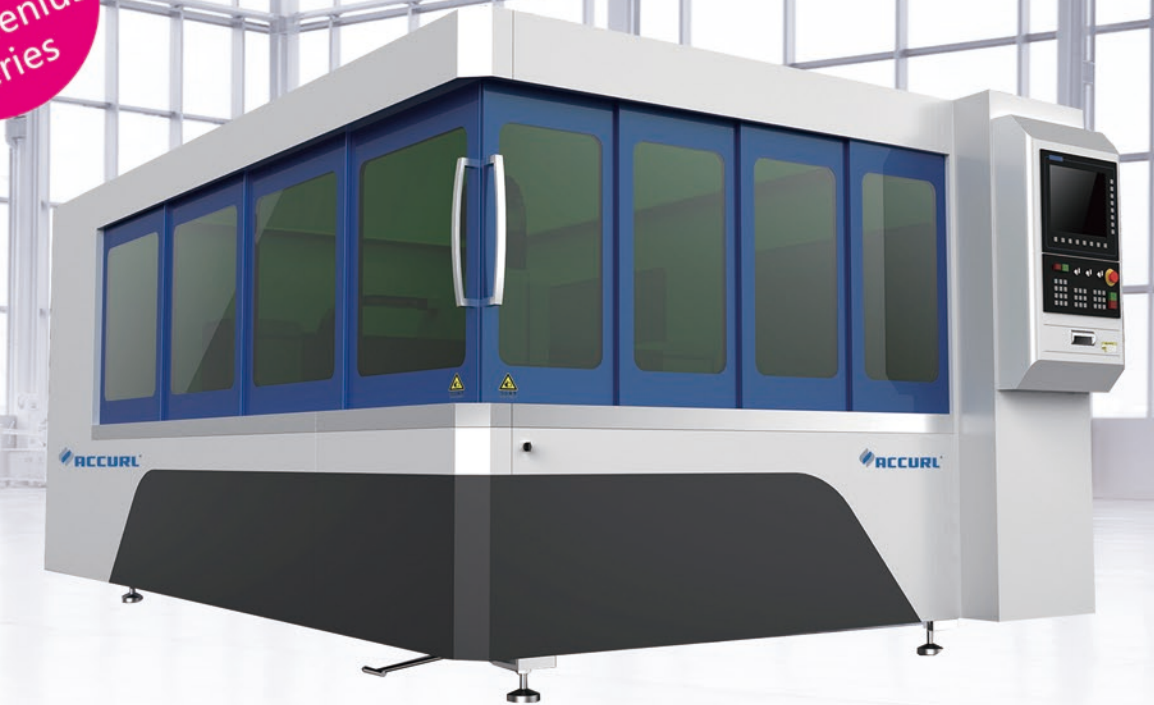

”  
Based on machinery design technology optimized through strict structural analysis, ACCURL has been manufacturing ultralight and high-precision industrial high energy laser cutting machines. In addition, we provide total solution for sheet metal working that customers want such as bending, welding, deburring, and loading automation.

# SmartLine 3015 FIBER

Fiber Laser | Tube Laser

Cutting speed: Max 100m/min  
 Positioning: 140m/min  
 Accelerations: 1.6G

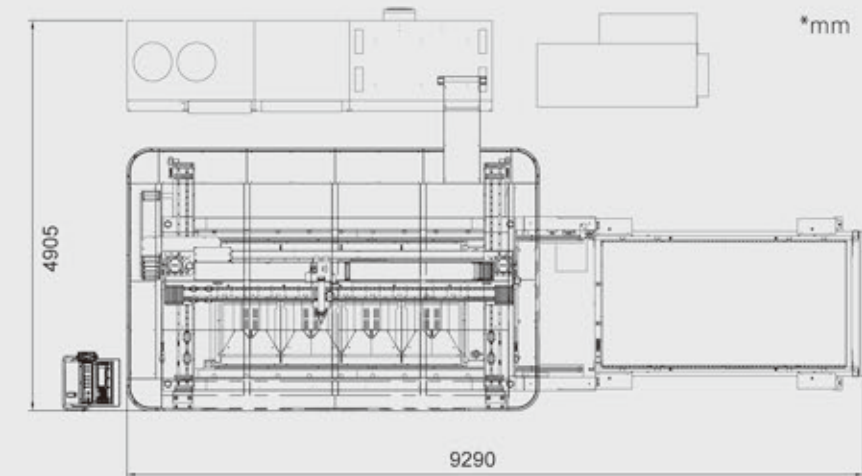
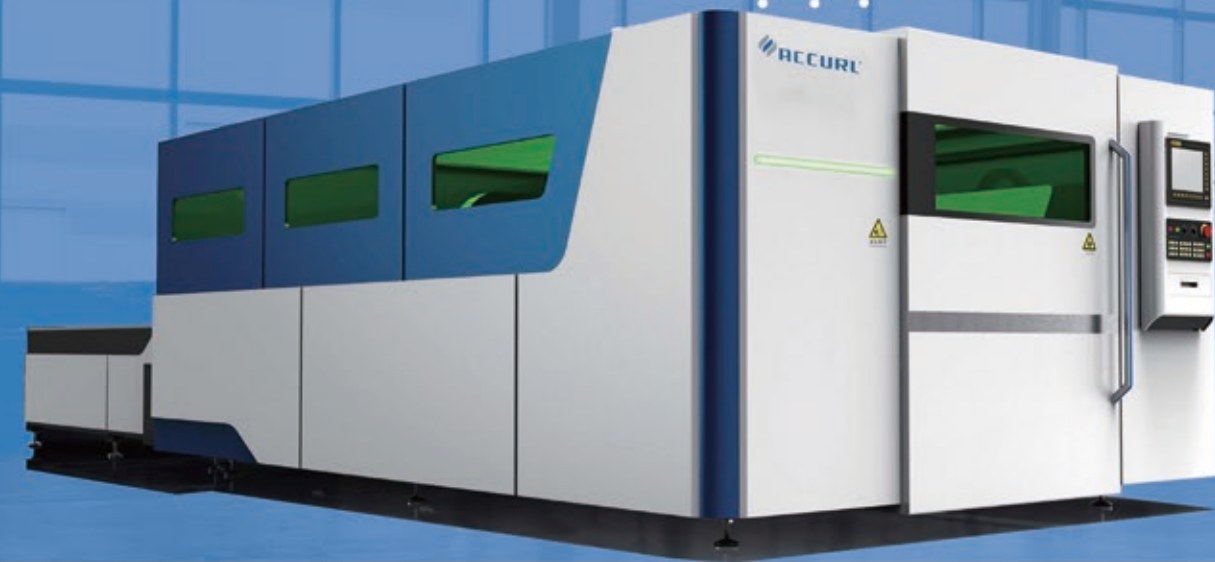

## BEST QUALITY, HIGH ACCURACY AND PRODUCTIVITY WITHOUT COMPROMISES ON THE WHOLE THICKNESS RANGE THANKS TO THE BEST INTEGRATION OF ALL MACHINE COMPONENTS

It combines the flexibility of the MasterLine with increased productivity and efficiency, obtained through the innovative use of materials such as the carbon fiber carriage and the synthetic granite frame.

The efficiency is further enhanced by Japan Shimpo racks & pinions which contributes increasing its productivity up to +15%, compared with conventional drive systems. Cutting quality further enhanced thanks to adaptive optics for the automatic management of the focal position.



### PRODUCTIVE

High dynamic racks & pinions increases productivity on thin sheets (+20%) compared with conventional drive systems.



### ACCURATE

Precise and repeatable in cutting and laser head positioning thanks to the effective CNC management of racks & pinions. Excellent cutting quality and dynamics on all materials.



### PROFITABLE

Low operating costs thanks to high energy efficiency and reduced maintenance.



### MODULAR

Suitable for any production need, offering a full range of solutions for automation.



### USER FRIENDLY

Can optional Single focusing lens system with automatic nozzle changer. Easy to use programming software and Prima Power operator interface.

## STANDARD EQUIPEMENT

- CypCut Fscut 2000 CNC System
- Reliable laser fiber source from 1 to 6 kw
- Japan Shimpo racks & pinions
- Modern body made of composite material
- Traverse made of steel
- Pallet changer without hydraulics
- Raytools Auto Cutting Head
- Interlock closing system
- Class 1 laser safety windows

## OPTIONAL EQUIPEMENT

- HYP CUT Touch FSCUT8000 TwinCAT CNC System
- Graphite Anti-burn Technology.
- Automatic nozzle cleaning 1.0
- Precitec Cutting head (Auto Focus)
- Pneumatic Pipe & Profile Cutting System
- Automatic loading / Unloading system SMART-LIFTER

## SPECIFICATIONS

MACHINE DIMENSION AND WEIGHT			
MACHINE MODEL	[um]	3015	4020
Lenght	[mm]	8000	10500
Width	[mm]	2600	3280
Height	[mm]	2250	2250
Weight	[kg]	12000	15000

WORKING AREA			
MACHINE MODEL	[um]	3015	4020
X axis	[mm]	3060	4060
Y axis	[mm]	1540	2050
Z axis	[mm]	100	100
Max.sheet weight	[kg]	1100	1800

1) Approximate values. The exact parameters are specified in the installation plan.



# MasterLine 3015 FIBER



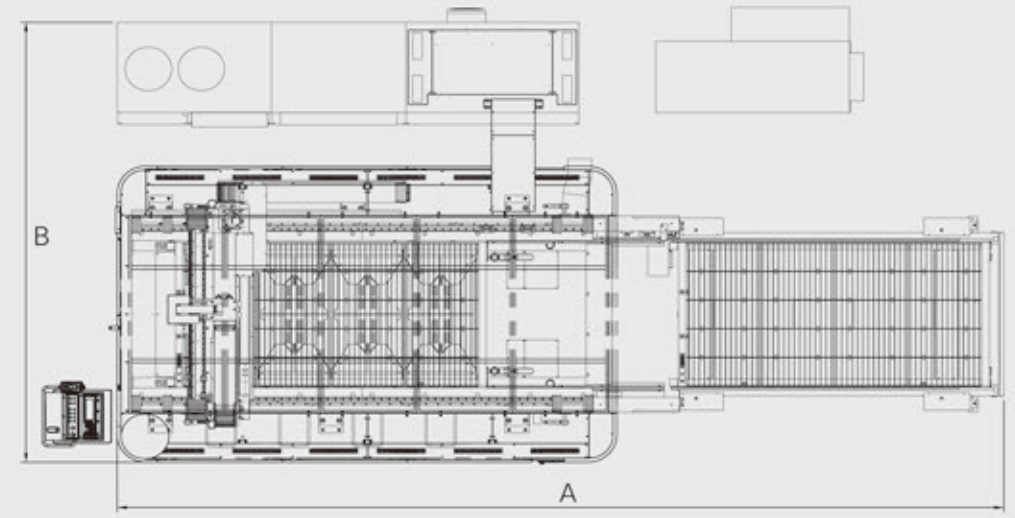

Fiber Laser | Tube Laser

Cutting speed:Max 150m/min  
Positioning:180m/min  
Accelerations:3G



## FLEXIBILITY AND HIGH QUALITY IN ALL THICKNESSES

MasterLine is the general purpose 2D laser cutting machine by Accurl utilized around the globe across a multitude of applications, manufacturing demands, and budgets. Available in five sizes and with laser powers ranging from 4,000 W to 20,000 W, Platino is suitable for every application. Change over to tube processing can be achieved with zero setup time. Thanks to its wide range of automation modules, MasterLine is the right solution for both small batches and large-scale production.

- 
**FLEXIBLE**  
 Suitable for a wide range of materials and thicknesses. Ready for round, square and rectangular tubes.
- 
**ACCESSIBLE**  
 Excellent visibility and maximum accessibility for the operator.
- 
**RELIABLE**  
 Fully tested and reliable platform thanks to the 20 years of experience with the Platino platform.
- 
**USER FRIENDLY**  
 Easy to use programming software and Accurl operator interface. Fast setup and reduced downtime.
- 
**COST-EFFECTIVE**  
 Excellent price/performance ratio.

## STANDARD EQUIPEMENT

- Beckhoff twincat touch CNC control
- Laser fiber source from 3 to 20 kw
- German Alpha racks & pinions
- Modern body made of composite material
- Traverse made of steel
- Superfast pallet changer
- Precitec procutter cutting head
- Interlock closing system
- Class 1 laser safety windows

## OPTIONAL EQUIPEMENT

- HypPanel Touch FSCUT8000 TwinCAT CNC System
- CypVision Laser Detection 2.1
- Automatic nozzle cleaning 1.0
- Automatic Nozzle Changer 2.0
- Automatic loading / Unloading system SMART-LIFTER
- Material screening and loading system SMART-TOWER

## SPECIFICATIONS

MACHINE DIMENSION AND WEIGHT						
MACHINE MODEL	[um]	3015	4020	6020	6025	8025
Lenght	[mm]	10000	11200	14000	14000	10800
Width	[mm]	3080	4100	4100	4750	4750
Height	[mm]	3060	3060	3060	3060	3180
Weight	[kg]	18100	21600	23300	24500	29500

WORKING AREA						
MACHINE MODEL	[um]	3015	4020	6020	6025	8025
X axis	[mm]	3060	4060	6060	6060	8060
Y axis	[mm]	1540	2040	2040	2540	2540
Z axis	[mm]	100	100	100	100	100
Max. sheet weight	[kg]	900	1400	2100	2300	3500

1)Approximate values.The exact parameters are specified in the installation plan.

## LASER CUTTING TECHNOLOGIES



### FULLY ANNEALED FRAME

- ACCURL steel frames undergo annealing at over 600° to relieve stress. They are built to last years of heavy use without distortion.
- Auto changing pallet system allows over 1800kg loading weight.

### OPTIMIZED BASE FRASME

- Very stiff and stable base frame
- Eight(8) zone & ducted exhaust system
- Dual synchronized twin servo motor drive system
- Helical rack & slant pinion drive system enables very smooth Movements.



### UITRA LIGHT-WEIGHT GANTRY STRUCTURE

- Light-weight cutting head assembly (Total weight 130 lbs) is designed for high dynamic movement, lowering the Tool enter Point to keep the cutting head from losing accuracy that is caused by whipping or drifting during high speed accell/decell movement



### CAST ALUMINIUM GANTRY

- Accurl's high tech aluminium crossbeam is cast in a specially manufactured 10-tonne steel mould.
- This allows better rigidity at 50% of the weight of traditional iron gantries, allowing higher acceleration with reduced inertia. This creates less wear and tear on the



## LASER DRIVES TECHNOLOGIES

### GRAPHITE ANTI-BURN TECHNOLOGY

- The area in the entire machine tool where the laser can shoot at is all covered and protected by 20mm thick graphite sheet.

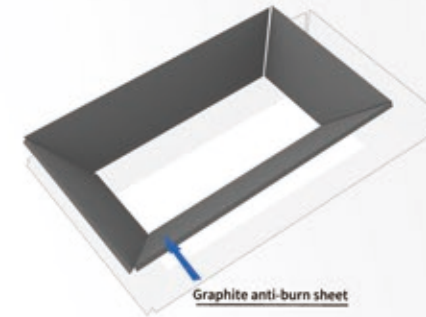

### BECKHOFF DYNAMIC DRIVES TECHNOLOGY

- High-speed EtherCAT communication
- Highly dynamic behaviour
- Brushless three-phase motors
- Flexible motor type selection



### ALPHA RACK AND PINONS SYSTEM

- ACCURL Laser uses the best German racks & pinions from Alpha Wittenstein.
- Advanced German engineering and recisionmanufacturing have created the highest quality linear systems available today.
- These are precision machined to Japanese standard JIS2.



### AUTOMATIC CLEANING & CHANGER NOZZLES

- After a predefined number of contours, the nozzle automatically performs self-cleaning, without need for the intervention of an operator.
- Adopting abundant & accurate control system can realize automatic replacement of nozzles according to different materials & thicknesses.



# BECKHOFF HIGH PERFORMANCE CNC SOLUTION

- The Accurl Masterline Fiber Laser is controlled with a Beckhoff CNC control unit which provides unprecedented control of the cutting process.
- EtherCAT and eXtreme Fast Control (XFC) technology enable fast switching functions at high processing speeds.



## PC-Based Control Technology

- Industrial PC with Multitouch touch screen 19".
- High-speed EtherCAT communication.
- The Beckhoff hardware and software platform
- Integrated retention brake control.
- Automatic adaptation of parameters.
- Adjustable error reaction.
- Motor feedback for absolute position registration.
- Absolute incremental position.

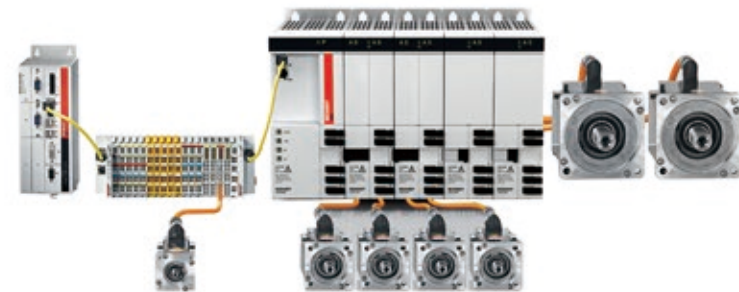

- In combination with the motion control solutions offered by the company's TwinCAT automation software, Beckhoff Drive Technology provides an advanced, all-inclusive drive system.

## Ready For Industry 4.0

- Industrie 4.0 for sheet metal working with TwinCAT Analytics and TwinCAT IoT

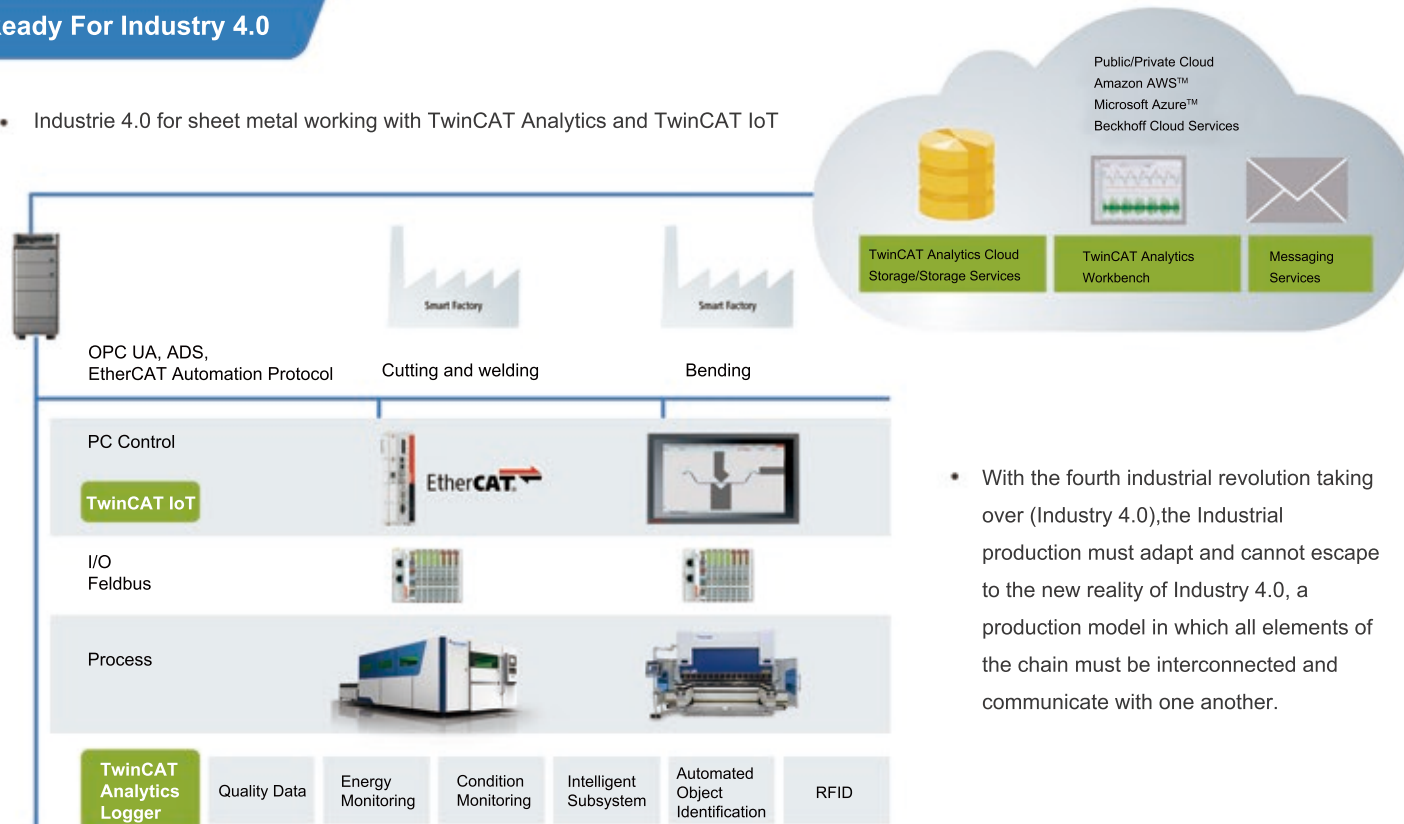

- With the fourth industrial revolution taking over (Industry 4.0), the Industrial production must adapt and cannot escape to the new reality of Industry 4.0, a production model in which all elements of the chain must be interconnected and communicate with one another.

# CAD/CAM SOFTWARE .LIBELLULA .CUT



- Libellula.CUT is the cutting edge of Libellula Universe and represents the highest expression of the technological know-how of Libellula.
- Thanks to its integrated CAD and the exclusive One-Click technology, Libellula.
- CUT creates or imports in a moment the geometric details from any other platform of drawing, automatically optimizing profiles and arranging them in an optimum manner for subsequent processing.



## Libellula.CUT Is Available For

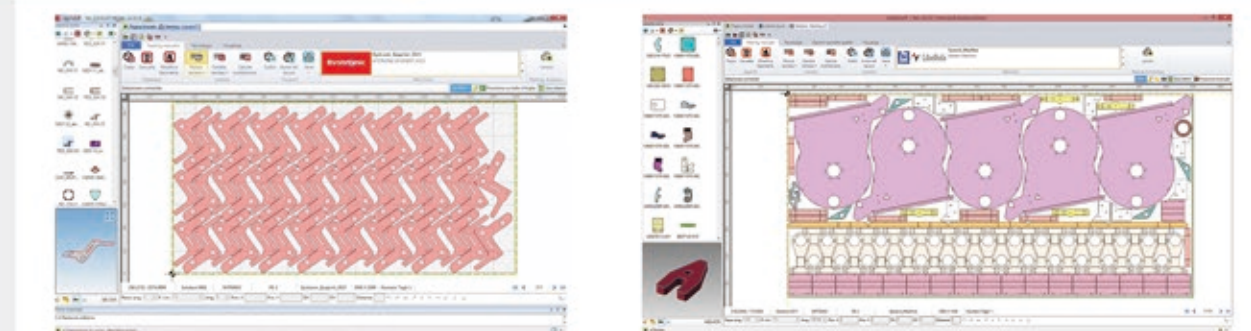

### Management of FMS lines and / or of the manual operations:

- Reduction of the cutting number of different nesting
- Automatic Skeleton cutting
- Systems management of loading / unloading and sorting systems

### Optimized information for the company with "Total Integration" additional Libellula modules

- Order Management with the option mod.ORDER module
- Warehouse management and reusable remnant with the mod.STORAGE option

# LASER CUTTING HEAD

Dynamic laser cutting machines require smart cutting heads for its operations.

ProCutter offers a fully-integrated sensor system that monitors the cutting process and provides the relevant information to the user.

The ProCutter ensures that each component can be re-manufactured at a high standard of quality.

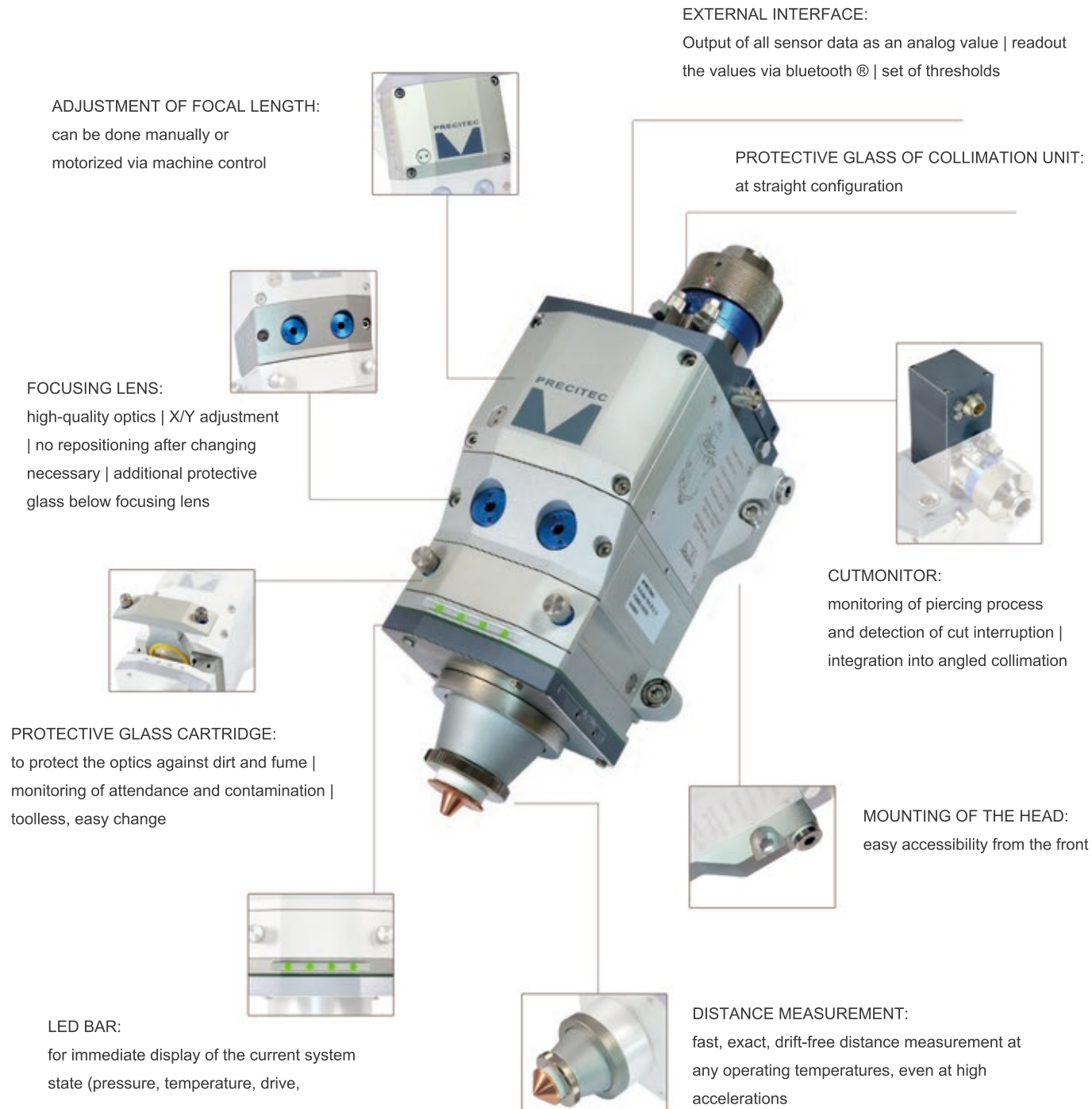

# PIERCETEC NEW PROCUTTER 2.0

The new ProCutter 2.0 generation impresses with its increased performance and new automation features. Faster, easier, more efficient, more enduring – this is how laser cutting is shaping up in the new generation, due to numerous developments.

The reliability and power capability has been perfected – up to the maximum laser power of 15 kW. By default, the ability to exchange the nozzles automatically is now provided. Automated piercing with the PierceTec technology package ensures a fast, clean and reproducible process. Due to direct water cooling (CoolTec) of the sheet metal, permanent stable mild steel cutting is possible.

- Motorized focus position adjustment for automatic machine setup and piercing work
- Lightweight and slim design created for fast acceleration and cutting speed
- Drift-free, fast-reacting distance measurement
- Permanent protective window monitoring
- Automated piercing with PierceTec
- Water cooling of the sheet metal with CoolTec
- Completely dustproof beam path with protective windows
- LED operating status display
- Output of all sensor data via WLAN to APP and machine control possible
- Pressure monitoring in the nozzle area (gas cutting) and in the head

### Maximum stamina!

It cuts and cuts and cuts...



### Easy parameter finding!

Quality ↗ Process window ↗



### Faster & more efficient!

Speed ↗ Gas efficiency ↗



### More laser-on-time!

Save time and costs.



**i**  
OPTIONAL

The future of manufacturing is undoubtedly digital. With the fourth industrial revolution taking over (a.k.a Industry 4.0), the Industrial production must adapt and cannot escape to the new reality of Industry 4.0, a production model in which all elements of the chain must be interconnected and communicate with one another.

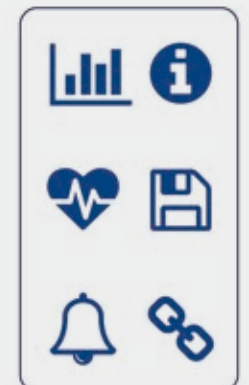
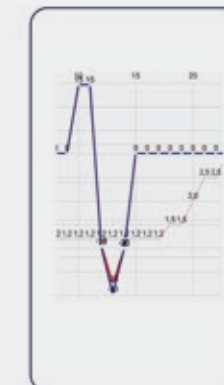

## FUNCTIONS / FIBER

### Supersonic Nozzle Shadow Graph



- Improving gas flow > Minimized trisction cutting.

### Smart Cut Cutting Result

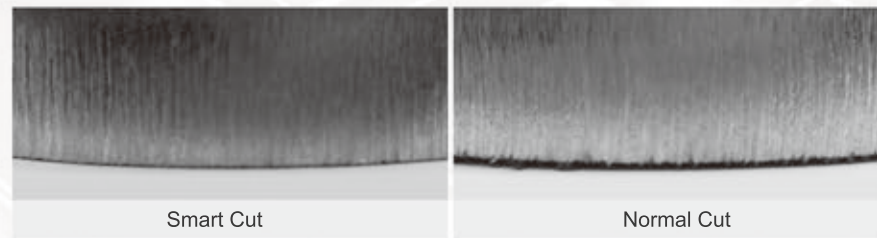

### SMART CUT 2.0

- Significant improvement of cutting stability in case of using supersonic nozzle.
- Approaching optimal efficiency based on laser cutting theory.
- Approaching optimal efficiency based on laser cutting theory.
- Improved cutting quality due to preventing top melt.
- Maximized fiber laser efficiency in case of 8mm melt cutting or over.

### FIBER CUTTING HEAD

- Measuring distance automatically.
- Auto edge detecting function.
- Automatic focal position adjustment.
- Applying protect window to long life time.
- Automatic focal diameter adjustment(Option).

### FIBER RESONATOR

- High energy efficiency & long life span.
- Simple structure and composition.
- Low maintenance cost (No external optics & laser gas).
- Strong in high reflecting materials.

## SMART CUT

Zoom 2.0 Head + Supersonic Nozzle

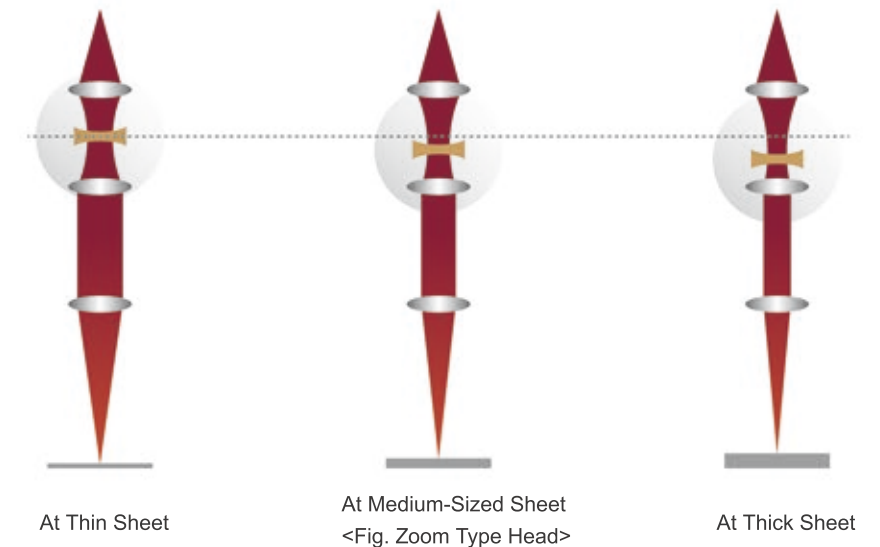

- Depend on thickness, it is available to control the beam size and make an exact angle of incidence.
- Widen cutting width, blow out the material melting easily.
- Max. laser power: 12 kW (with wave lengths of 1030-1090 nm)
- Magnification ratio: 1.2 / 1.5 / 2.0 / 2.5 / 3.0 / 3.5 / 4.0

### ProCutter 2.0 | ProCutter manual

The new ProCutter 2.0 generation impresses with its increased performance and new automation features. Faster, easier, more efficient, more enduring – this is how laser cutting is shaping up in the new generation, due to numerous developments.



ProCutter 2.0  
with motorized  
adjustment of focal length



ProCutter Manual  
with manual  
adjustment of focal length

# SPECIFICATIONS

## FIBER

	Max. Work Size mm	Power kw	Electric Consumption kw			U-Axis
			Resonator	Chiller	CNC	
Genius 3015	3,048*1,524	3.0	8.5	3.6	5	★
		4.0	11.8	5.2		
		6.0	18.4	7.7		
SmartLine 3015	3,048*1,524	3.0	8.5	3.6	5	★
		4.0	11.8	5.2		
		6.0	18.4	7.7		
SmartLine 4020	4,064*2,050	3.0	8.5	3.6	8	★
		4.0	11.8	5.2		
		6.0	18.4	7.7		
SmartLine 6025	6,096*2,540	3.0	8.5	3.6	8	★
		4.0	11.8	5.2		
		6.0	18.4	7.7		
SmartLine 8025	8,250*2,540	3.0	8.5	3.6	8	★
		4.0	11.8	5.2		
		6.0	18.4	7.7		

- : Not apply   ★ : Option

## TUBE

	Max. Work Size mm	Max. Cross Section mm			Power kw	Cutting Capacity mm				
		Round	Square	Rectangle		MS	SUS	AL	Brass	Cu
Sheet and Tube cutting	6,000	∅165	120 x 120	Diagonal 165	2.5	6.4	5	4		
PC 6015 Fiber	6,000	∅165	120 x 120	Diagonal 165	2.0	6.4	5	4	5	3
					3.0	10	6.4	6.4	5	5
PC 6020 Fiber	6,000	∅210	160 x 160	Diagonal 210	2.0	6.4	5	4	5	3
					3.0	10	6.4	6.4	5	5
PC 7525 Fiber	7,500	∅250	175 x 175	Diagonal 245	2.0	6.4	5	4	5	3
					3.0	10	6.4	6.4	5	5

\*The specification is subject to change without prior notice.

# AUTOMATED PRODUCTION

QIAOLIAN•LASER systems can be integrated with different types of automation, from the loading/unloading server to the automated storage tower for completely unmanned production. The ACCURL software allows the integrated management of third-party integration systems thanks to the open source concept.

## Automatic loading / Unloading system

### Smart Cell

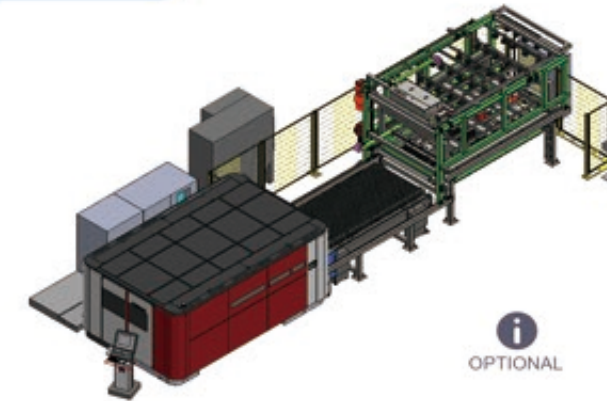

OPTIONAL

## Automatic loading / Unloading system

### Smart Lifter

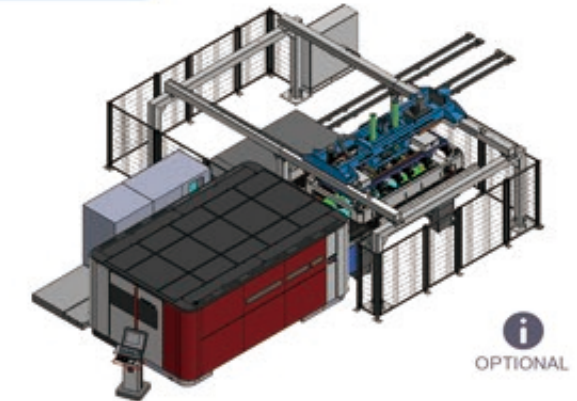

OPTIONAL

## Automatic loading system

### Smart Loader

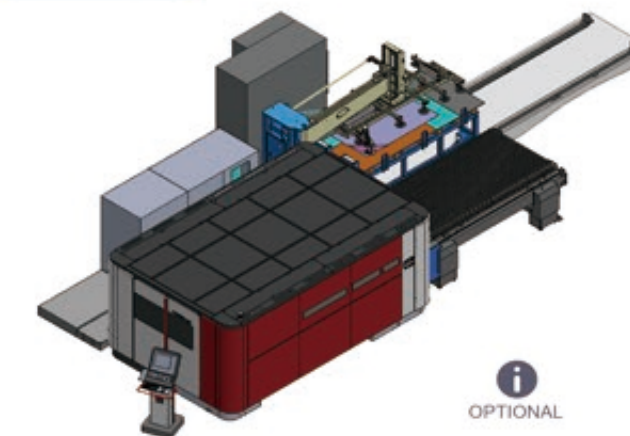

OPTIONAL

## Material screening loading system

### Smart Tower

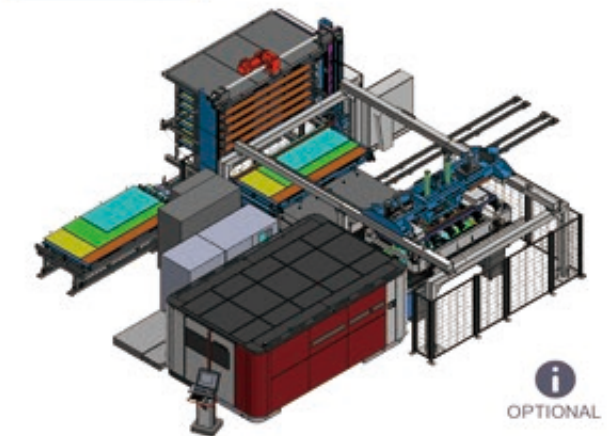

OPTIONAL

	3015	4020	4025	6020	6025
Smart Cell	•				
Smart Lifter	•	•	•	•	•
Smart Loader	•	•			
Smart Tower	•	•			

# THICKNESSES AND MATERIALS

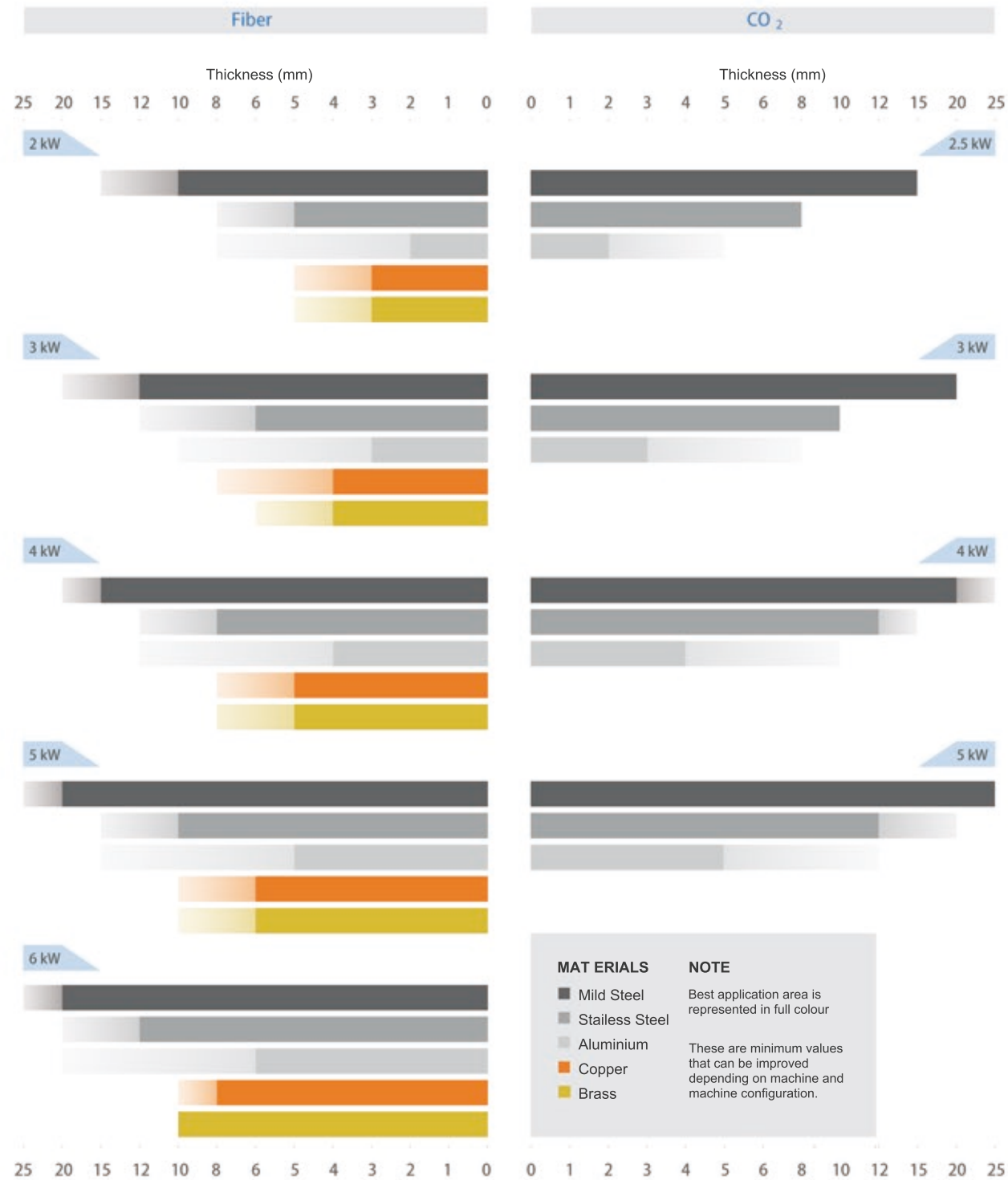

Fast and efficient also for non-ferrous materials: particularly productive for medium-low thickness.



High-quality results to the whole spectrum of processable thicknesses (0.8 to 25 mm).

# TECHNICAL SPECIFICATIONS

MODELS	X axis stroke mm	Y axis stroke mm	Z axis stroke mm
Masterline 3015	3150	1550	150
Masterline 4020	4150	2050	150
Masterline 6020	6150	2050	150
Masterline 8020	8150	2050	150
Masterline 6025	6150	2550	150
Masterline 8025	8150	2550	150
Masterline 10025	10150	2550	150

Note: Altri modelli sono disponibili a richiesta  
Note: others models are available upon request

AXES SPECIFICATION	Speed m/min	Acceleration G	Positioning resolution mm	Positioning tolerance mm
Axis X	120	2G (1G per/for Y 2500)	0,01	+/- 0,03
Axis Y	120	2G (1G per/for Y 2500)	0,01	+/- 0,03
Axis Z	40	-	0,01	+/- 0,03
Axes X-Y interpolated	170	2G (1G per/for Y 2500)	0,01	+/- 0,03

MAX CUTTING CAPACITY	1 KW	1.5 KW	2 KW	3 KW	4 KW	5 KW	6 KW	8 KW
Mild Steel	8 mm	10 mm	15 mm	20 mm	20 mm	22 mm	25 mm	25 mm
Stainless Steel	5 mm	6 mm	8 mm	12 mm	12 mm	15 mm	20 mm	22 mm
Aluminum	3 mm	5 mm	6 mm	10 mm	12 mm	12 mm	15 mm	20 mm
Brass	1 mm	2 mm	3 mm	5 mm	6 mm	8 mm	8 mm	10 mm
Copper	1 mm	2 mm	3 mm	5 mm	6 mm	8 mm	8 mm	10 mm

# TUBE LASER CUTTING

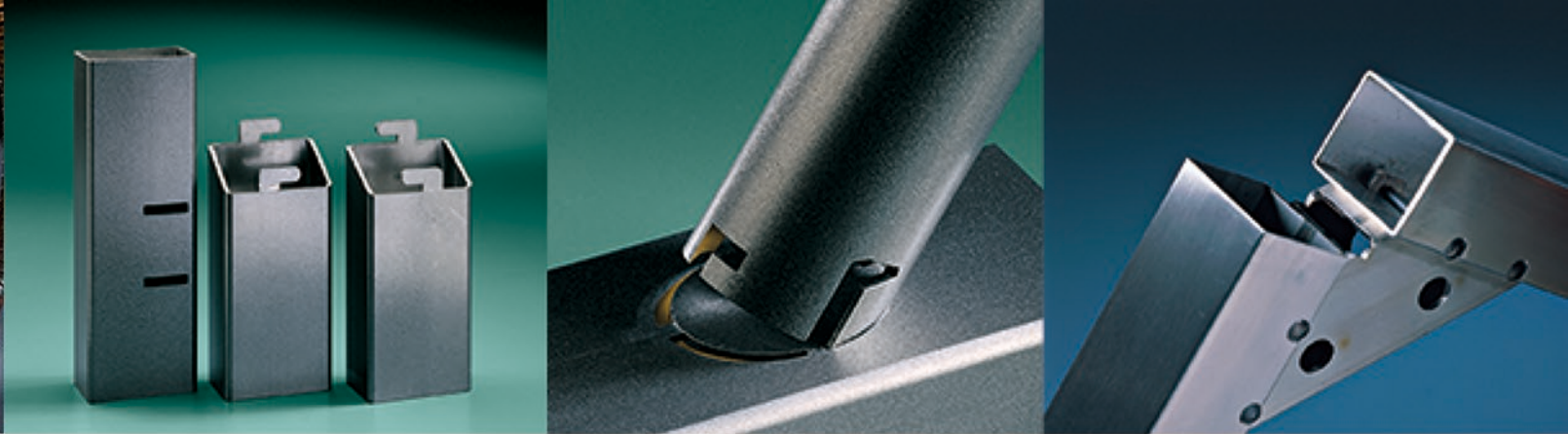

## SPECIFICATIONS

<b>WALL THICKNESS</b> 19mm maximum on straight cuts 12.7mm on bevel cuts maximum bevel is 5mm	<b>CONVEYOR SETUP</b> Can queue up to 5pieces of varying material sizes/lengths at a time	<b>DRAWINGS</b> Solid model tubing data can be imported directly via 3D .iges, .satand .step file formats. Manually inputting the tube info,the software is possible but requires more time.
<b>LENGTH</b> 6000mm - 0mm maximum	<b>SMALL PARTS CATCHER</b> Can handle parts up to 698.5mm larger sizes require manual unloading	<b>TOLERANCES</b> Are similar to laser table tolerances +/-0.8mm to +/-0.25mm depending on material



**ROUND PIPE**  
 Min Diam: 20  
 Max Diam: 210 X 210



**CHANNEL**  
 Min: -  
 Max: -



**WIDE FLANGE**  
 Min: -  
 Max: -



**SQUARE/REC. TUBE**  
 Min: 20 X 20  
 Max: 150 X 150



**ANGLE**  
 Min: -  
 Max: -



**OTHER SHAPES**  
 Min: -  
 Max: -

unit : mm

1

Mechanical structural integrated machine bed,achieving stable performance. Rack and guide rails adopt fully-covered protection to avoid from dust contamination, thus to enhance the life span of transmission parts and ensure running accuracy of machine bed;

2

This model adopts AC servo motors driving system, transmission parts adopt racks, pinions and linear guide rails, ensuring high-speed, high precision and high reliability of the equipment;

3

Fully automatic pneumatic chuck can achieve quick self-centering and objects clamping, and gas pressure can be adjusted at the same time, to make sure clamping strength is stable and reliable;

4

Adopts second-feeding method especially for small pipes processing, solving the precision problem of cutting 6-meter long small pipes from traditional machinery.

### Tube-Cutting Technical Specifications

Max Diameter (mm)	Ø210
Max Square Tube Dimension(mm)	140x140
Max Rectangular Tube Dimension (mm)	170x120
Min. Diameter (mm)	Ø20 (Ø12 Option)
Max. Tube Length (mm)	6500
Min. Tube Length (for automatic loading)	3000
Max. Tube Weight (kg/m)	37,5
Max. Material Thickness (mm) (for 2 kW )	8
Min. Material Thickness(mm)	0,8
Automatic Loading	Optional
Automatic Unloading	Optional
Cutting Head	2D
Amount of Chuck	1
Centering Chuck	Yes
Last Cut Tube Length (mm)	185
Velocity of Driver Chuck (m/dk.)	90
Acceleration of Driver Chuck (m/s²)	10
Accuracy (mm)	±0,20
Positioning Accuracy(mm)	±0,05
Tube Types	Pipe, Square, Rectangular, Elliptic H, C, U, L